

TROUBLESHOOTING

Before you call for service, review the troubleshooting firstly.

Problem	Possible cause	What to do
First using, there is some smell.	This smell comes from the motor.	New motor will give out some smell and it is normal, after using some time, this situation will disappear.
After switch on, the appliance does not work.	Up-cover wasn't assembled correctly or hoop does not lock the up-cover correctly.	This appliance is equipped with the safe switch at the top edge of body. Re-assemble up-cover and make sure that the hoop lock the up-cover correctly.
Appliance stop working suddenly.	Plug loose from power socket. Some hard material stuck in the filter. Motor's thermal fuse cut off power.	Firstly switch off immediately. Check if plug loose from power socket. Check if some hard materials stuck up with the filter. If above is OK, unplug the appliance and take the appliance to any service agent for further check.
Big noise during working.	Does not assemble filter correctly and cause out of dynamic equilibrium.	Switch off the appliance and unplug. Re-assemble filter and make sure that it fits correctly.
Juice volume is less normal.	Some vegetable fiber stuck up in the filter.	Fruits or vegetables with much fiber sticks to the filter. Take out the filter to clean.
Some pulp is in juice.	It is normal.	Don't need to take any step.

EVEREADY >>>
INDUSTRIES INDIA LTD.

1, Middleton Street, Kolkata-700071, India
Consumer Care - address as above - Ph. 1800-102-4041
Email: appliancecare@eveready.co.in

EVEREADY

Appliances



FULL APPLE JUICER



J600

2 YEAR
WARRANTY

600 W

USER MANUAL

* Images are only indicative.
Actual product may differ from the one shown on the carton.

IMPORTANT SAFEGUARDS

This product is designed and intended for household use only.

Please read all the instructions carefully before using Eveready Full Apple Juicer. Even if you are familiar with the product then also place it handy for future reference.

1. Ensure that the voltage specified on rating label of your product corresponds to your house electricity supply voltage before plug in.
2. To protect against electrical hazards, do not immerse the product, electrical cord or plug in water or any other liquid.
3. Place the product on a flat, dry surface before any operation.
4. Never operate the product unless the lid is secured in place with the help of the hoop and do not leave it unattended.
5. Do not run the Juicer without load for long time.
6. Juice container provided with this Juicer should not be used for storage. Pulp chamber should be emptied and cleaned thoroughly after each use.
7. Keep Juicer atleast 6 inches away from the wall.
8. Do not operate the appliance when it is damaged or it works improperly. Sieve should never be used if it has deformed or been damaged. Bring the appliance to the nearest authorized service facility for examination, repair or adjustments to avoid any hazard.
9. Switch off and remove the plug from the power outlet when it is not in use or before assembling and disassembling parts, cleaning or carrying out any maintenance of the appliance.
10. When using extension cord with your appliance, make sure that the extension cord is correctly wired and rated for its use.
11. Do not leave the appliance unattended when it is connected to the main supply outlet.

12. Never remove the cover, unless the sieve has completely stopped rotating.
13. Use the pusher provided to push fruits with slight pressure for juicing. Never use your finger to push fruits down for juicing.
14. Do not let the power cord hang over the edge of a table, counter or in touch of any hot surface.
15. When unattended and while fixing it's sieve, ensure that the speed switch is in off position.
16. Keep the appliance out of reach of children at all times. Close supervision is necessary when used near children or by physically challenged persons or by people who lack experience to use same appliance.
17. Do not abuse the power cord. Never carry the juicer by the power cord or yank it to disconnect it from the outlet, instead, grasp the plug and pull out to disconnect.
18. The use of attachment or accessories not recommended or sold by Eveready may result in fire, electric shock or personal injury.
19. To clean, wipe the exterior with a damp cloth and handle blades carefully as they have sharp edges.
20. The appliance is intended for household use and not to be used at outdoors.

Do not operate or place any part of this product on or near any hot surface (such as gas or electric burner or near a heated oven).

PARTS IDENTIFICATION

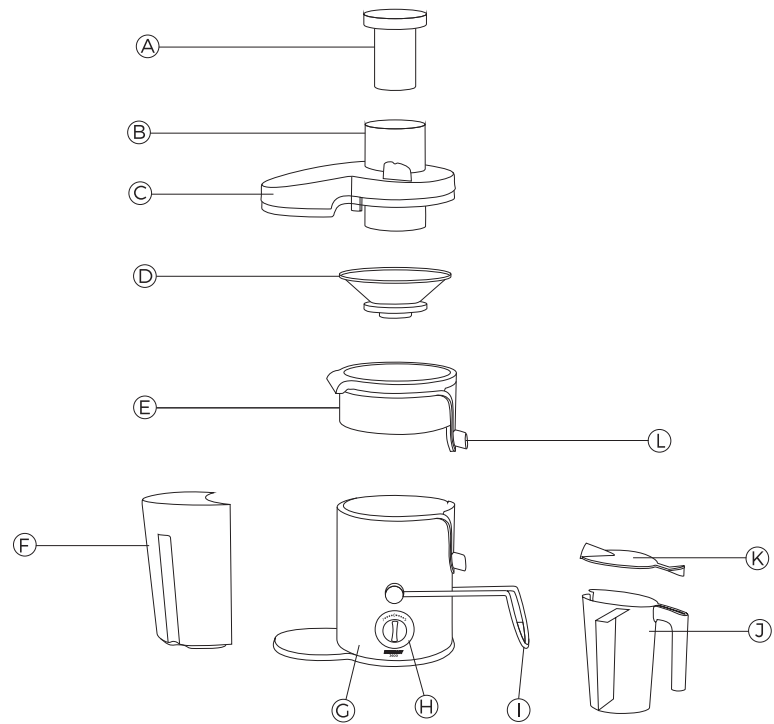

- | | |
|-------------------------|---|
| A. Pusher | G. Body |
| B. Feeder | H. Speed control knob |
| C. Transparent cover | I. Hoop |
| D. Sieve | J. Juice container with froth separator |
| E. Juice collector bowl | K. Cover |
| F. Pulp-container | L. Spout |

ASSEMBLING INSTRUCTION

Important: Prior to assembling the juicer, always ensure that the appliance is unplugged and it's switch lies on stop (0) position. Before using, clean all parts thoroughly

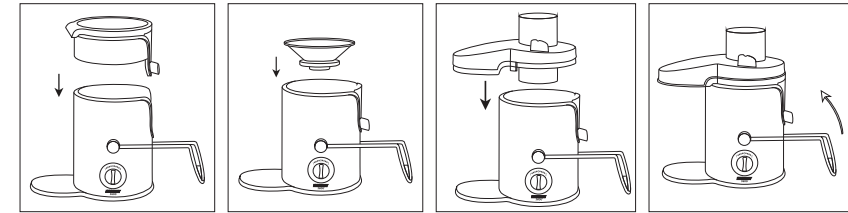

Fig. 1

Fig. 2

Fig. 3

Fig. 4

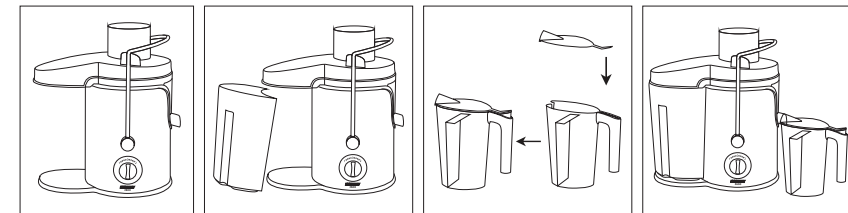

Fig. 5

Fig. 6

Fig. 7

Fig. 8

1. Put the Juice collector bowl (E) onto the body (G) and make it fit perfectly. See Fig. 1
2. Put the Sieve (D) into the Juice collector bowl (E) and make sure that it be fitted perfectly. See Fig. 2
3. Put the Transparent cover (C) onto the body (G) and make sure that it be fitted perfectly. See Fig. 3 and Fig. 4
4. Pull up the hoop (I) onto the Transparent cover (C) to lock Transparent cover. This is very important. If hoop does not lock Transparent cover, then the appliance will be not working. See Fig. 4 and Fig. 5
5. Put the pulp-container (F) under Transparent cover (C) and make sure that it fits perfectly. Otherwise pulp will flow out of tank. See Fig. 6
6. Put the cover (K) onto the juice container (J) and place the container under Spout (L). See Fig. 7 and Fig. 8

OPERATIONAL INSTRUCTION

Important:

- Do not operate the appliance for more than 2 min. at one time
- Do not put your finger or other hard materials into the feeder when the appliance is working. Otherwise it will cause serious injury or damage the appliance

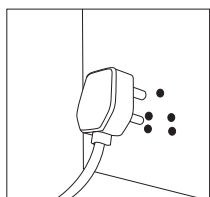

Fig. 9

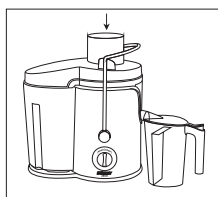

Fig. 10

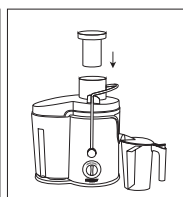

Fig. 11

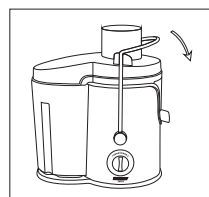

Fig. 12

1. Plug in the appliance, Fig. 9. Before plug in please ensure that the voltage must meet appliance indication on rating label.
2. Switch on the appliance and put materials like fruit, vegetable into the feeder (B), juice will come out from spout (L). If material is stuck in feeder, use pusher (A) to push materials down. See Fig. 10 and Fig. 11
3. After juicing, switch off the appliance and release hoop down. See Fig. 12
4. This appliance is with 2 speeds shift: Fig. 13

"0" = stop

"1" = low speed, suitable for soft fruits

"2" = high speed, suitable for all fruits and vegetables

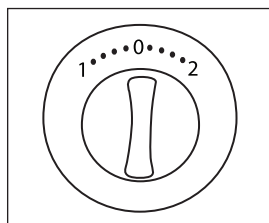

Fig. 13

HOW TO CLEAN JUICER

1. Switch off the juicer and unplug from power socket before cleaning.
2. As per step of assembling reverse method to be done, to disassemble all parts of the juicer one by one.
3. Use brush to clean all parts under the water tap.
4. Use the damp cloth to wipe base, do not let any liquid go into the body.

TECHNICAL SPECIFICATION

Model	FULL APPLE JUICER, J600
Power	600W
Voltage	230V, AC
Frequency	50Hz